

92G1

PRODUCT SPECIFICATIONS

SINGLE STAGE GAS FURNACE

FORM NO. 92G1-100 (10/2013)



CONFIGURATIONS

- Upflow/Horizontal
- Downflow

HEAT EXCHANGER DESIGN

- Aluminized steel design primary heat exchanger with crimped no weld construction
- AL 29-4C Stainless steel secondary heat exchanger

BURNER

- Aluminized steel inshot burners for smooth ignition

CABINET DESIGN

- Compact 33" height
- Standardized widths for easy coil fit

AIR DELIVERY SYSTEM

- Multi-speed PSC blower motor
- Easily removable slide-out blower design

CONTROLS

- Single Stage Gas Valve
- Self diagnostics saves last 5 fault codes regardless of power interruption
- Control features electronic air cleaner and humidifier terminals

VENTING

- Designed certified for direct and non direct applications

INSTALLATION FEATURES

- Left or right utility connection
- Designed certified for direct and non-direct vent applications
- Zero step horizontal conversion
- Removable floor base for bottom return air

WARRANTY

10 year limited parts warranty / lifetime heat exchanger warranty available. See limited warranty document for details.

MODEL NUMBER GUIDE

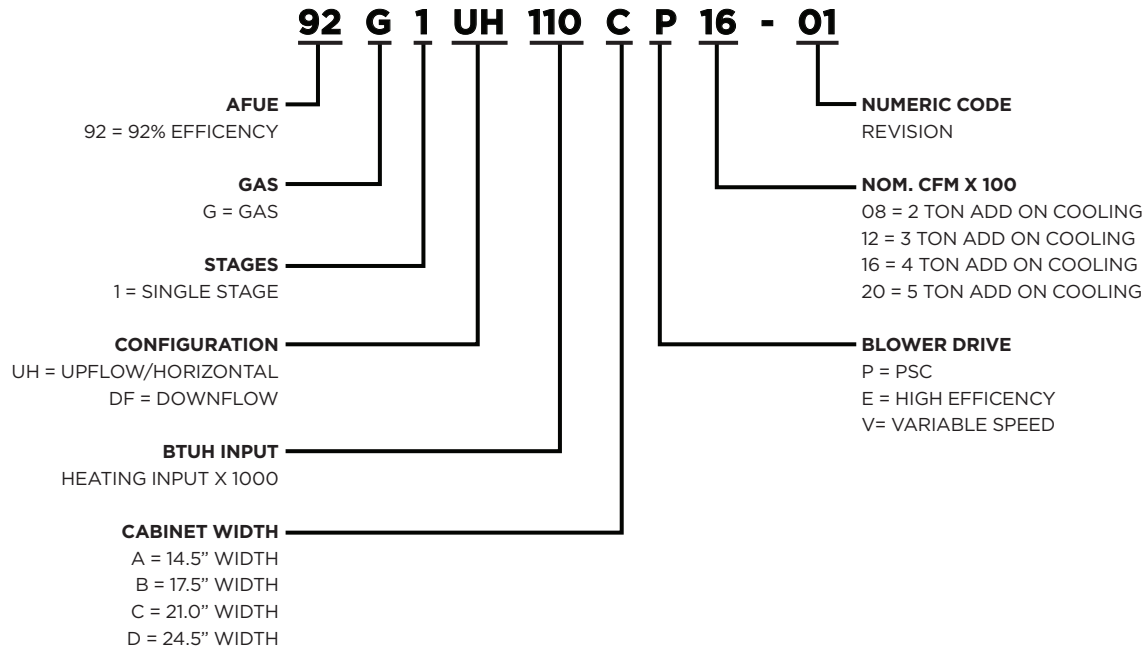

PHYSICAL AND ELECTRICAL DATA

	Model	Input (Btuh)	Output (Btuh)	AFUE (ICS)	Nom. Cooling Capacity	Gas Inlet (in.)	Volts/Hz/Phase	Max. Time Delay Breaker or Fuse	Nominal F.L.A.	Trans. (V.A.)	Approx. Shipping Weight (lbs.)
UPFLOW / HORIZONTAL	92G1UH045BP08	44,000	41,000	92.1%	1.5 - 2	1/2	120 - 60 - 1	15	3.1	40	120
	92G1UH045BP12	44,000	42,000	92.1%	2.5 - 3	1/2	120 - 60 - 1	15	6.1	40	122
	92G1UH070BP08	66,000	62,000	92.1%	1.5 - 2	1/2	120 - 60 - 1	15	3.1	40	125
	92G1UH070BP12	66,000	62,000	92.1%	2.5 - 3	1/2	120 - 60 - 1	15	6.1	40	127
	92G1UH090CP12	88,000	83,000	92.1%	2 - 3	1/2	120 - 60 - 1	15	6.1	40	143
	92G1UH090CP16	88,000	83,000	92.1%	3 - 4	1/2	120 - 60 - 1	15	8.2	40	146
	92G1UH110CP16	110,000	104,000	92.1%	3 - 4	1/2	120 - 60 - 1	15	8.2	40	155
	92G1UH110CP20	110,000	104,000	92.1%	4 - 5	1/2	120 - 60 - 1	15	10.0	40	161
	92G1UH135DP20	135,000	124,000	92.1%	4 - 5	1/2	120 - 60 - 1	15	10.0	40	178
DOWNFLOW	92G1DF045BP12	44,000	42,000	92.1%	2.5 - 3	1/2	120 - 60 - 1	15	6.1	40	124
	92G1DF070BP12	66,000	62,000	92.1%	2.5 - 3	1/2	120 - 60 - 1	15	6.1	40	129
	92G1DF090CP16	88,000	84,000	92.1%	3 - 4	1/2	120 - 60 - 1	15	8.2	40	147
	92G1DF110CP20	110,000	104,000	92.1%	4 - 5	1/2	120 - 60 - 1	20	11.5	40	162

Note: For vent length and clearances to combustibles, please reference installation instructions.

BLOWER PERFORMANCE DATA

	Model	Motor Size (hp)	Blower Size	Temp Rise (°F)	Blower Speed	CFM @External Static Pressure - " w.c.							
						0.20	0.30	0.40	0.50	0.60	0.70	0.80	0.90
UPFLOW / HORIZONTAL	92G1UH045BP08	1/5	10 x 8	40 - 70	High	1125	1090	1065	1020	945	910	790	735
					Med/High	895	870	865	825	780	740	670	575
					Med	755	725	715	675	640	585	510	460
					Low	680	660	635	605	555	505	455	390
	92G1UH045BP12	1/3	10 x 8	25 - 55	High	1550	1480	1425	1355	1320	1225	1135	1025
					Med/High	1330	1295	1280	1190	1165	1110	1050	950
					Med	1150	1140	1105	1085	1030	975	920	800
					Low	1000	975	970	940	900	855	780	700
	92G1UH070BP08	1/5	10 x 8	50 - 80	High	1125	1090	1065	1020	945	910	790	735
					Med/High	895	870	865	825	780	740	670	575
					Med	755	725	715	675	640	585	510	460
					Low	680	660	635	605	555	505	455	390
	92G1UH070BP12	1/3	10 x 8	40 - 70	High	1535	1440	1405	1340	1255	1165	1060	955
					Med/High	1340	1300	1255	1200	1125	1080	990	895
					Med	1150	1110	1075	1045	995	935	870	750
					Low	1025	1000	975	945	875	820	750	660
	92G1UH090CP12	1/3	10 x 8	50 - 80	High	1565	1525	1485	1431	1365	1295	1200	1060
					Med/High	1335	1300	1295	1260	1210	1155	1065	955
					Med	1145	1135	1110	1090	1035	995	930	820
					Low	970	965	960	940	900	860	745	695
	92G1UH090CP16	1/2	10 x 10	40 - 70	High	1925	1850	1790	1700	1610	1540	1415	1270
					Med/High	1675	1640	1575	1540	1455	1365	1265	1165
					Med	1405	1400	1395	1350	1295	1225	1125	1060
					Low	1205	1175	1170	1140	1100	1030	980	900
	92G1UH110CP16	1/2	10 x 10	50 - 80	High	1935	1885	1830	1750	1660	1540	1420	1290
					Med/High	1675	1660	1585	1565	1485	1380	1290	1175
					Med	1455	1410	1385	1320	1280	1230	1140	1045
					Low	1230	1200	1190	1165	1105	1060	945	850
92G1UH110CP20	3/4	11 1/2 X 10	40 - 70	High	2370	2270	2185	2115	2020	1910	1815	1680	
				Med/High	2180	2120	1995	1955	1865	1765	1675	1575	
				Med	1950	1885	1835	1760	1721	1630	1555	1440	
				Low	1670	1635	1605	1545	1485	1425	1330	1275	
92G1UH135DP20	3/4	11 1/2 X 10	45 - 75	High	2350	2260	2135	2095	1980	1885	1810	1690	
				Med/High	2170	2100	2050	1950	1875	1820	1690	1620	
				Med	1945	1915	1825	1805	1720	1680	1580	1505	
				Low	1710	1675	1655	1575	1540	1480	1405	1360	

BLOWER PERFORMANCE DATA

	Model	Motor Size (hp)	Blower Size	Temp Rise (°F)	Blower Speed	CFM @External Static Pressure - " w.c.							
						0.20	0.30	0.40	0.50	0.60	0.70	0.80	0.90
DOWNFLOW	92G1DF045BP12	1/3	10 x 8	25 - 55	High	1500	1450	1350	1300	1195	1140	1025	945
					Med/High	1340	1290	1235	1170	1095	1020	920	800
					Med	1165	1125	1090	1035	990	895	840	700
					Low	1015	975	920	875	840	780	695	605
	92G1DF070BP12	1/3	10 x 8	50 - 80	High	1405	1355	1305	1270	1175	1105	1040	920
					Med/High	1255	1225	1165	1110	1080	1000	925	825
					Med	1055	1045	1010	975	925	855	790	680
					Low	930	900	890	835	815	745	670	560
	92G1DF090CP16	1/2	10 x 10	40 - 70	High	1910	1825	1730	1630	1530	1430	1300	1185
					Med/High	1775	1705	1620	1530	1450	1340	1245	1110
					Med	1575	1530	1475	1405	1330	1260	1145	1045
					Low	1340	1325	1285	1240	1175	1095	1015	915
	92G1DF110CP20	1	11½X 10	50 - 80	High	2285	2220	2185	2045	1965	1820	1625	1455
					Med/High	2120	2015	1950	1830	1710	1610	1510	1390
					Med	1850	1770	1750	1680	1575	1495	1400	1350
					Low	1540	1535	1530	1500	1445	1370	1315	1210

DIMENSIONS (IN.)

	Model	A	B	C	D
UPFLOW / HORIZONTAL	A92G1UH045BP08	17-1/2	16-3/8	16	7-5/8
	A92G1UH045BP12	17-1/2	16-3/8	16	7-5/8
	A92G1UH070BP08	17-1/2	16-3/8	16	7-5/8
	A92G1UH070BP12	17-1/2	16-3/8	16	7-5/8
	A92G1UH090CP12	21	19-7/8	19-1/2	9-3/8
	A92G1UH090CP16	21	19-7/8	19-1/2	9-3/8
	A92G1UH0110CP16	21	19-7/8	19-1/2	9-3/8
	A92G1UH0110CP20	21	19-7/8	19-1/2	9-3/8
	A92G1UH0135DP20	24-1/2	23-3/8	23	11-1/8
DOWNFLOW	A92G1DF045BP12	17-1/2	16-3/8	16	15-1/2
	A92G1DF070BP12	17-1/2	16-3/8	16	15-1/2
	A92G1DF090CP16	21	19-7/8	19-1/2	19
	A92G1DF110CP20	21	19-7/8	19-1/2	19

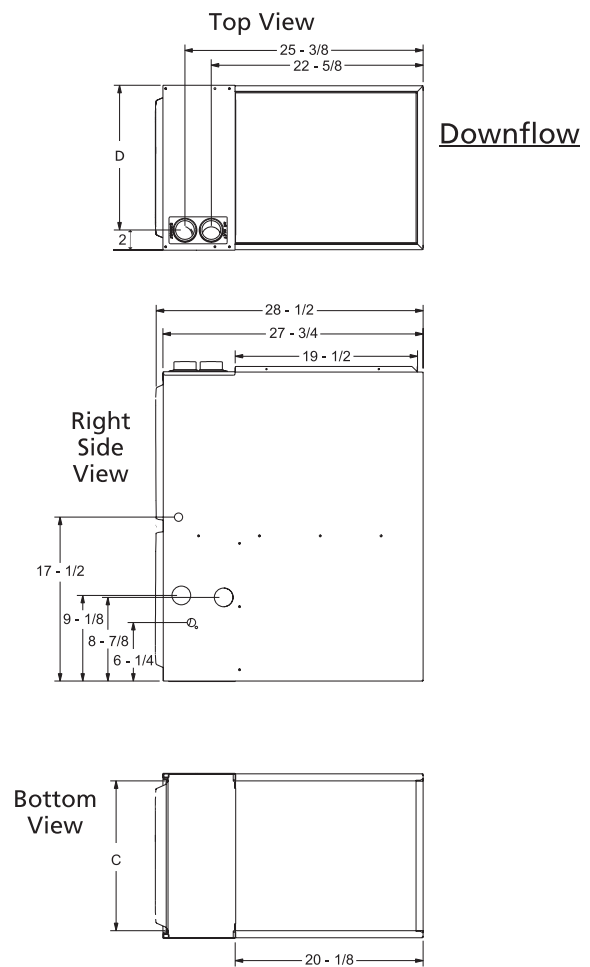
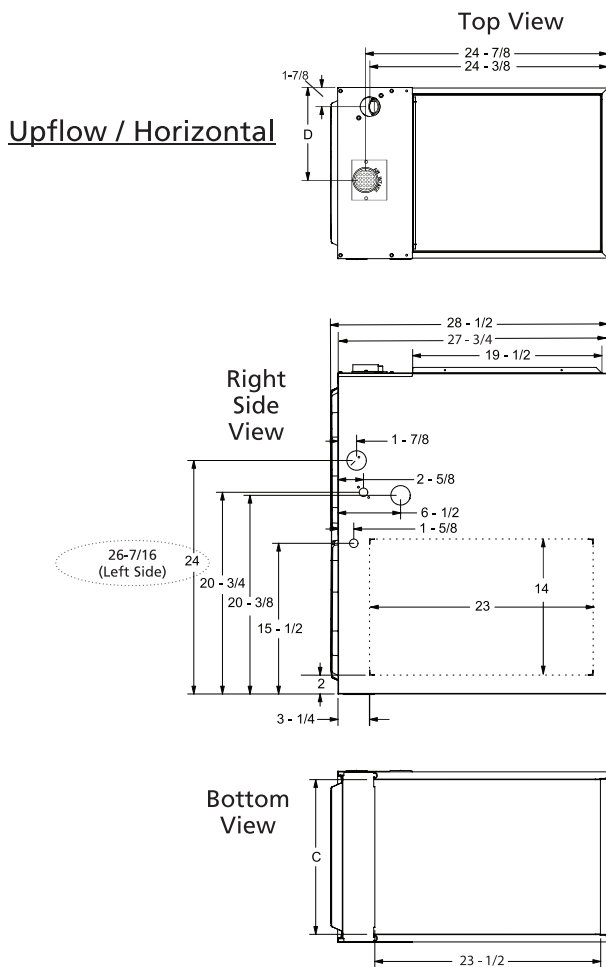
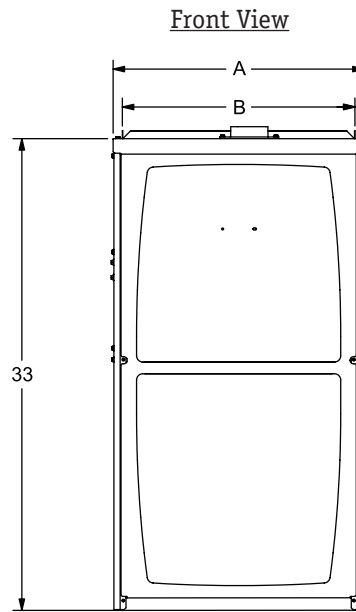

ACCESSORY LIST

CATALOG NUMBER	DESCRIPTION
External Filter Rack kits	
1.841018	1 pack (16 x 25)
1.841039	10 pack (16 x 25)
Natural to LP kits	
68W75	1-Stage - 90
Return Air Base	
68W62	17.5" B Width
68W63	21.0" C Width
68W64	24.5" D Width
Downflow Combustible Flooring Base	
11M60	17.5" B Width
11M61	21.0" C Width
Night Service Kits	
68W80	Single Stage
Horizontal Suspension Kit	
51W10	80% & 90% Kit
Flush Mount Termination (90% Furnaces only) US Only	
51W11	2" & 3" Vent Version
Concentric Vent Kit (90% Furnaces only) US Only	
71M80	1-1/2" Vent Version
69M29	2" Vent Version
60L46	3" Vent Version

For vent length and clearances to combustibles, please reference installation instructions.



1-800-448-5872

All specifications and illustrations subject to change without notice and without incurring obligations.